

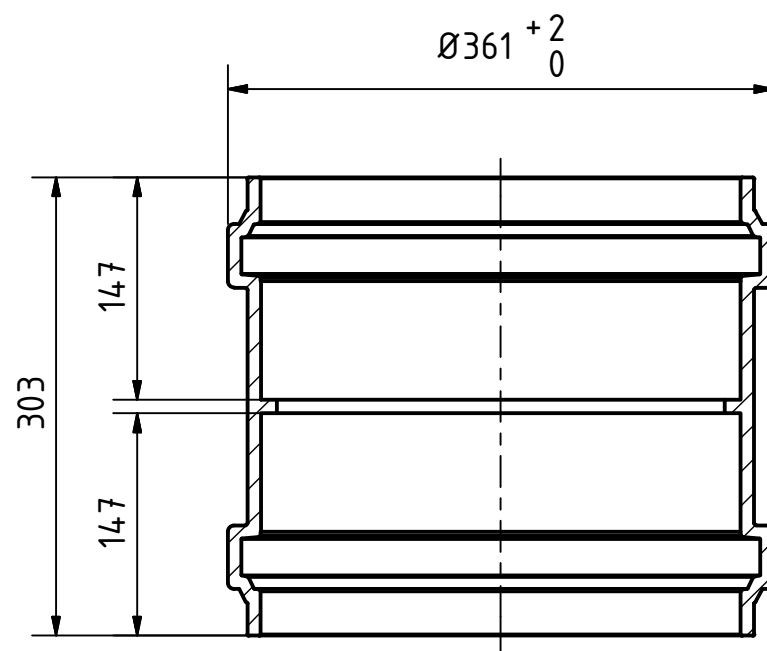

A-A ( 1 : 5 )



		Maße nach DIN EN 14 758-Teil1		Art.Nr.: 777800		Maßstab 1:5	
				Material: PP-MD			
				Datum		Name	
				Gezeichnet 14.11.2016		A.Schmedes	
				Kontroll.			
Status		Änderungen		Datum		Name	
Gebr. Ostendorf Kunststoffe GmbH Rudolf-Diesel-Str. 6-8 D-49377 Vechta verkauf@ostendorf-kunststoffe.com www.ostendorf-kunststoffe.com						<h1>KG 2000</h1>	
						1 A3	
Schutzvermerk nach DIN ISO 16016 beachten!							