

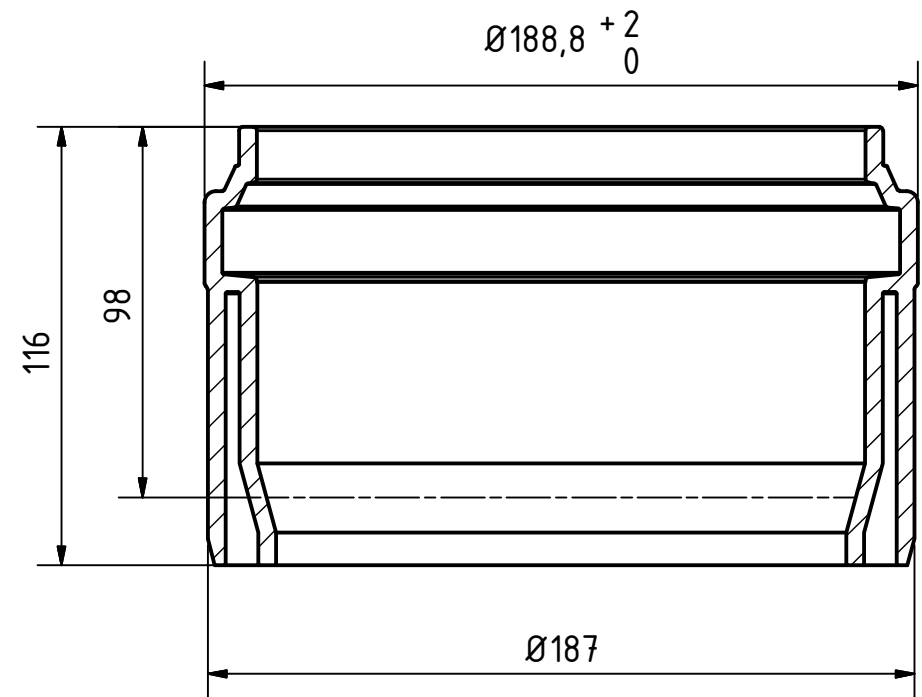

A-A (1 : 2)



		Maße nach DIN EN 14 758-Teil1		Art.Nr.: 777590		Maßstab 1:2		
				Material: PP-MD				
			Datum	Name		<h1>KG 2000</h1>		
			Gezeichnet	18.11.2016	A.Schmedes			
			Kontroll.					
Status	Änderungen	Datum	Name	Norm				
Gebr. Ostendorf Kunststoffe GmbH Rudolf-Diesel-Str. 6-8 D-49377 Vechta verkauf@ostendorf-kunststoffe.com www.ostendorf-kunststoffe.com						1 A3		
						Schutzvermerk nach DIN ISO 16016 beachten!		