

A-A (1 : 5)

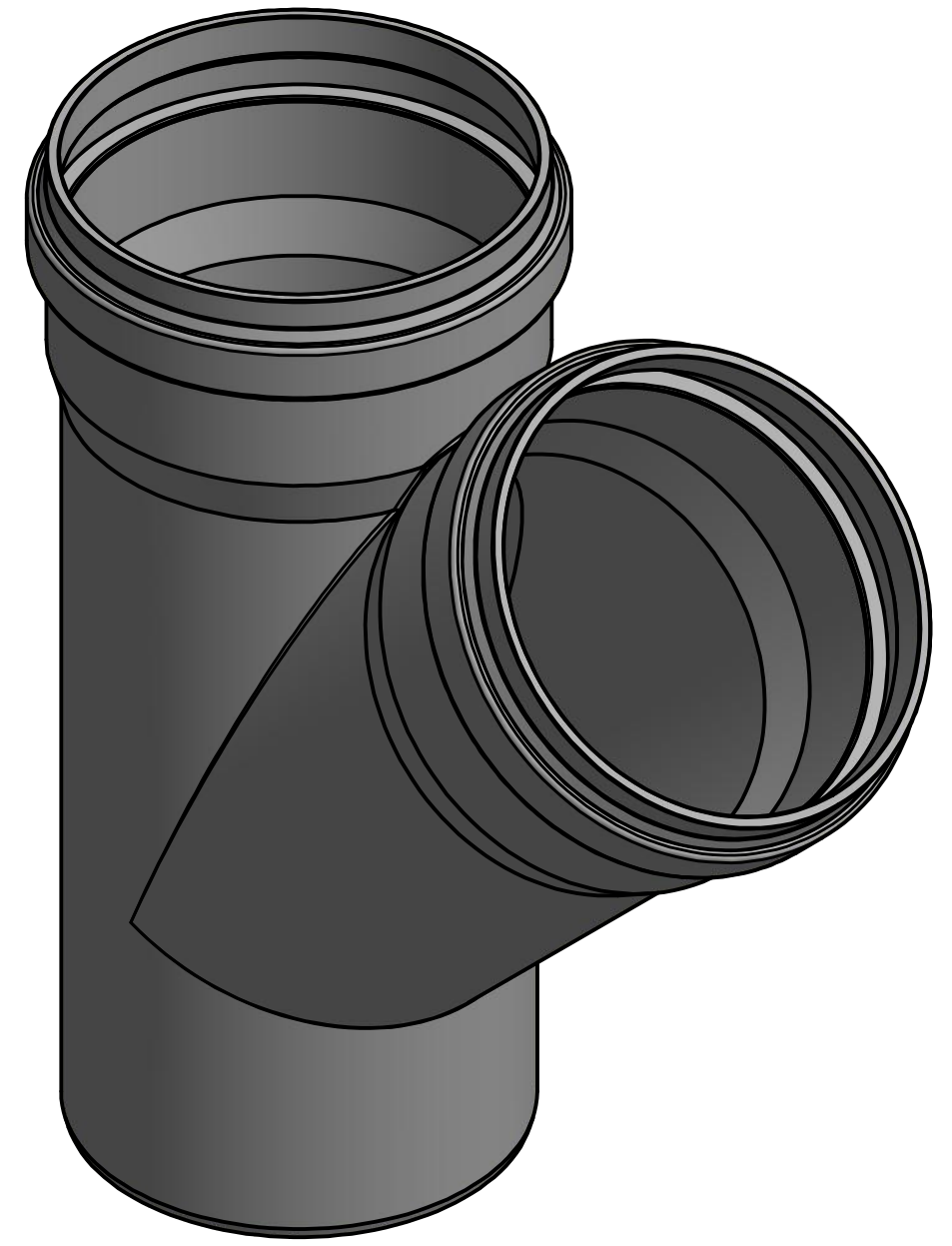
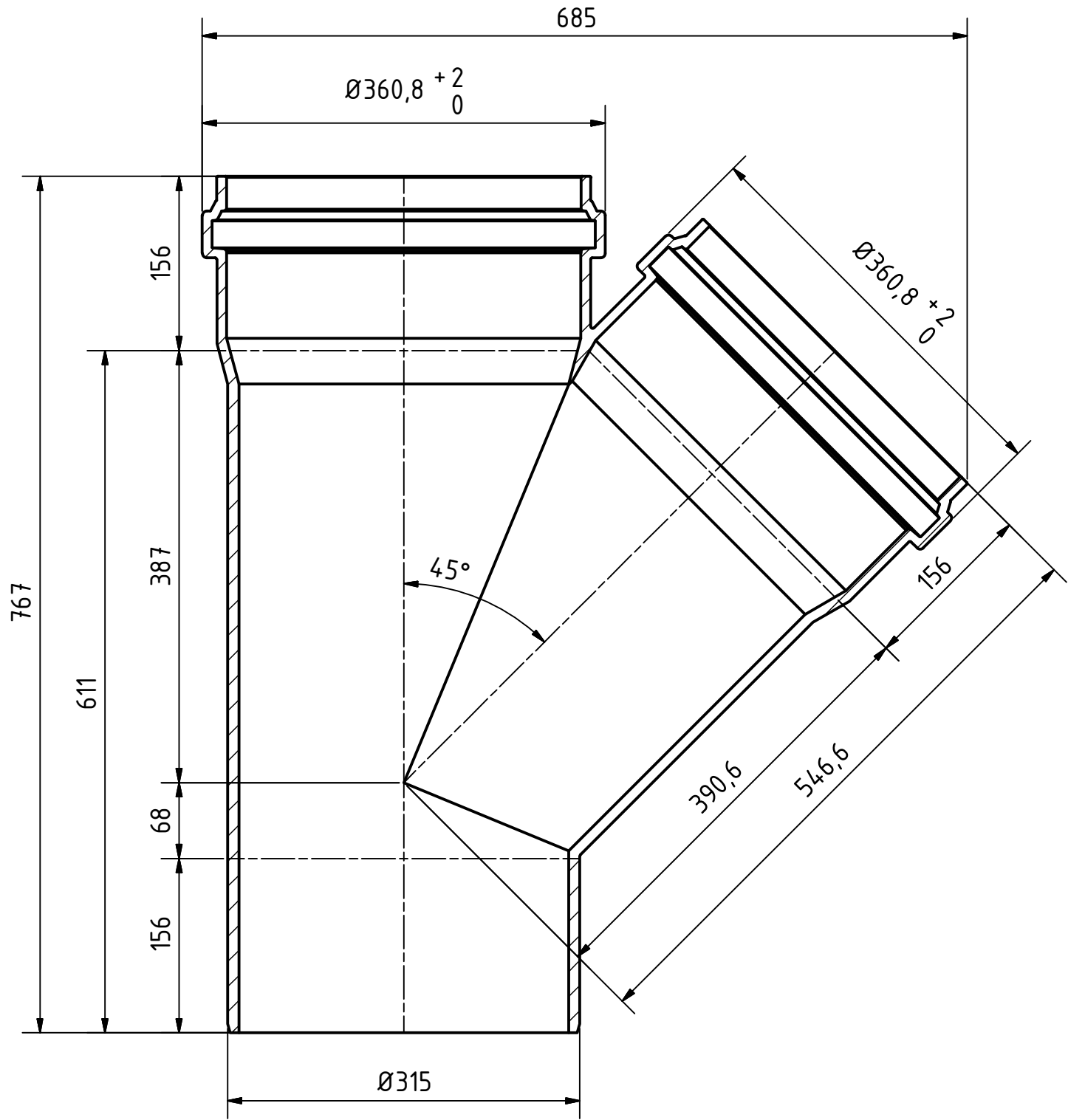
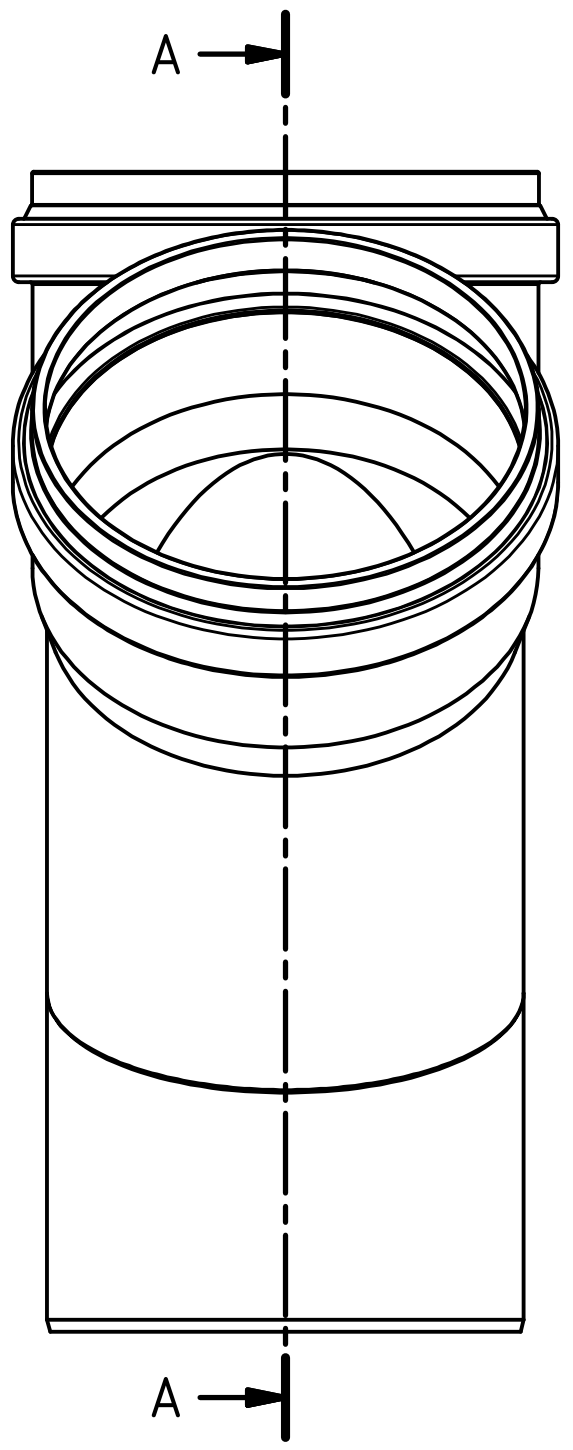

		Maße nach DIN EN 14 758-Teil1		Art.Nr.: 772880		Maßstab 1:5	
				Material: PP-MD			
		Datum		Name		<h1>KG 2000</h1>	
		Gezeichnet 14.06.2016		A.Schmedes			
		Kontroll.					
Status	Änderungen	Datum	Name	Norm			
Gebr. Ostendorf Kunststoffe GmbH Rudolf-Diesel-Str. 6-8 D-49377 Vechta verkauf@ostendorf-kunststoffe.com www.ostendorf-kunststoffe.com					KG2000EA Abzweig DN/OD 315/315/45°		1
							A3
					Schutzvermerk nach DIN ISO 16016 beachten!		