

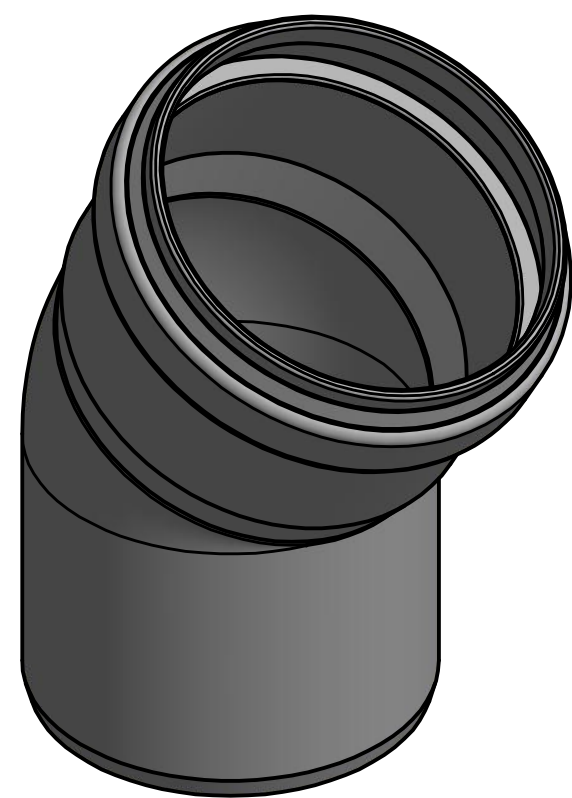

A-A ( 1 : 2 )

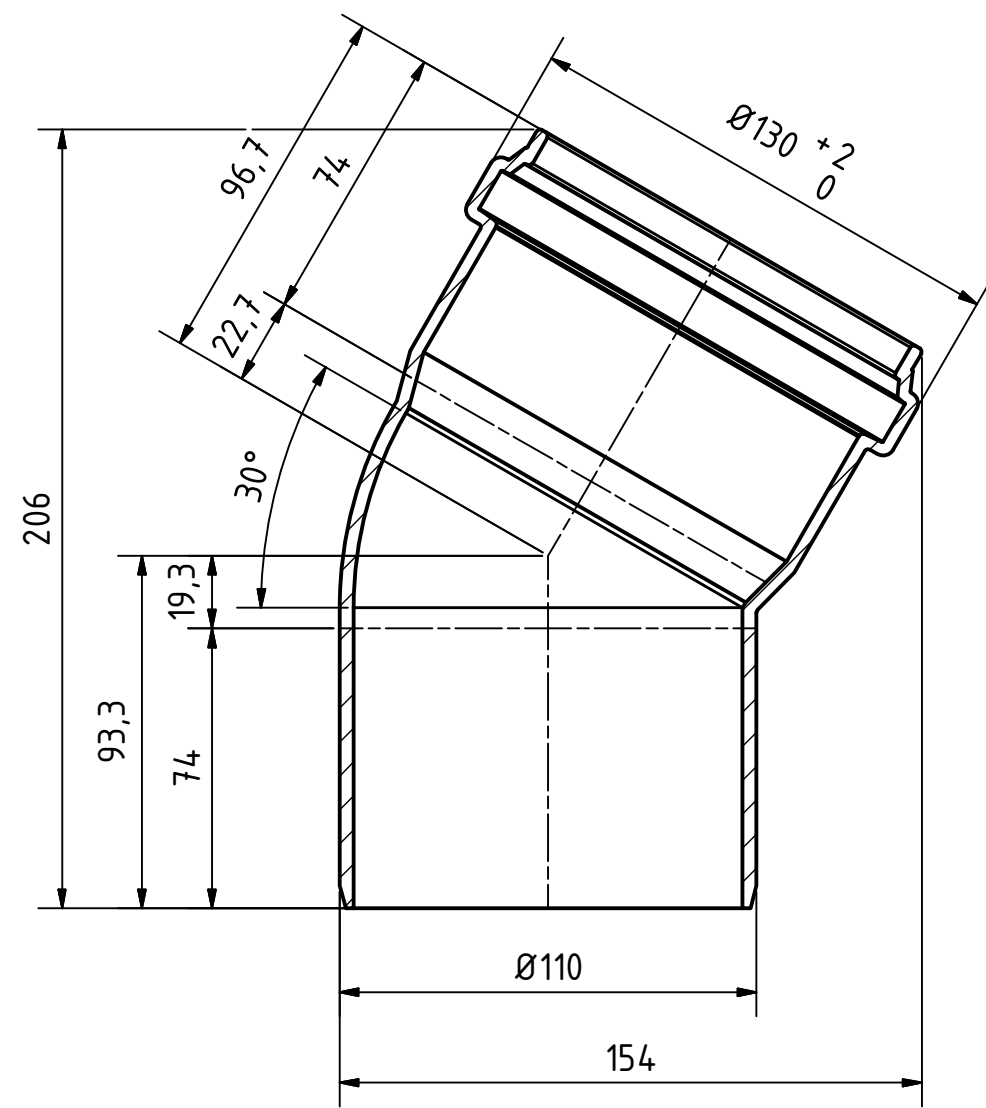

		Maße nach DIN EN 14 758-Teil1		Art.Nr.: 771310		Maßstab 1:2		
				Material: PP-MD				
		Datum		Name		<h1>KG 2000</h1>		
		Gezeichnet: 17.11.2016		A.Schmedes				
		Kontroll.						
Status	Änderungen	Datum	Name	Norm				
Gebr. Ostendorf Kunststoffe GmbH Rudolf-Diesel-Str. 6-8 D-49377 Vechta verkauf@ostendorf-kunststoffe.com www.ostendorf-kunststoffe.com						KG2000B Bogen DN/OD 110/30°		1
						Schutzvermerk nach DIN ISO 16016 beachten!		