

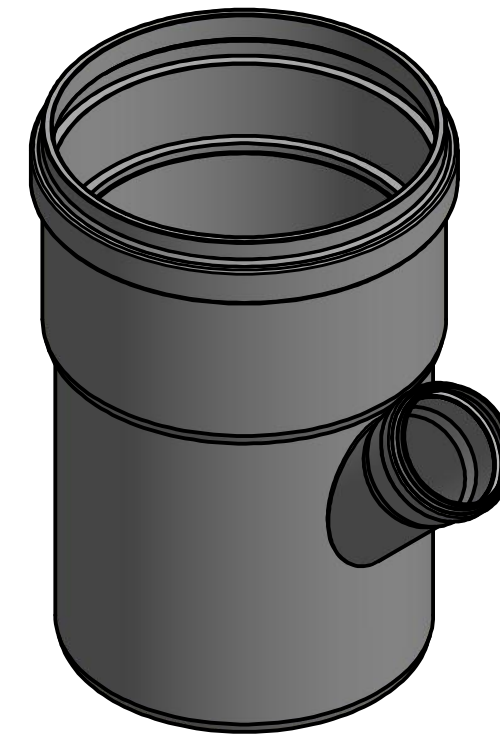

A-A ( 1 : 10 )

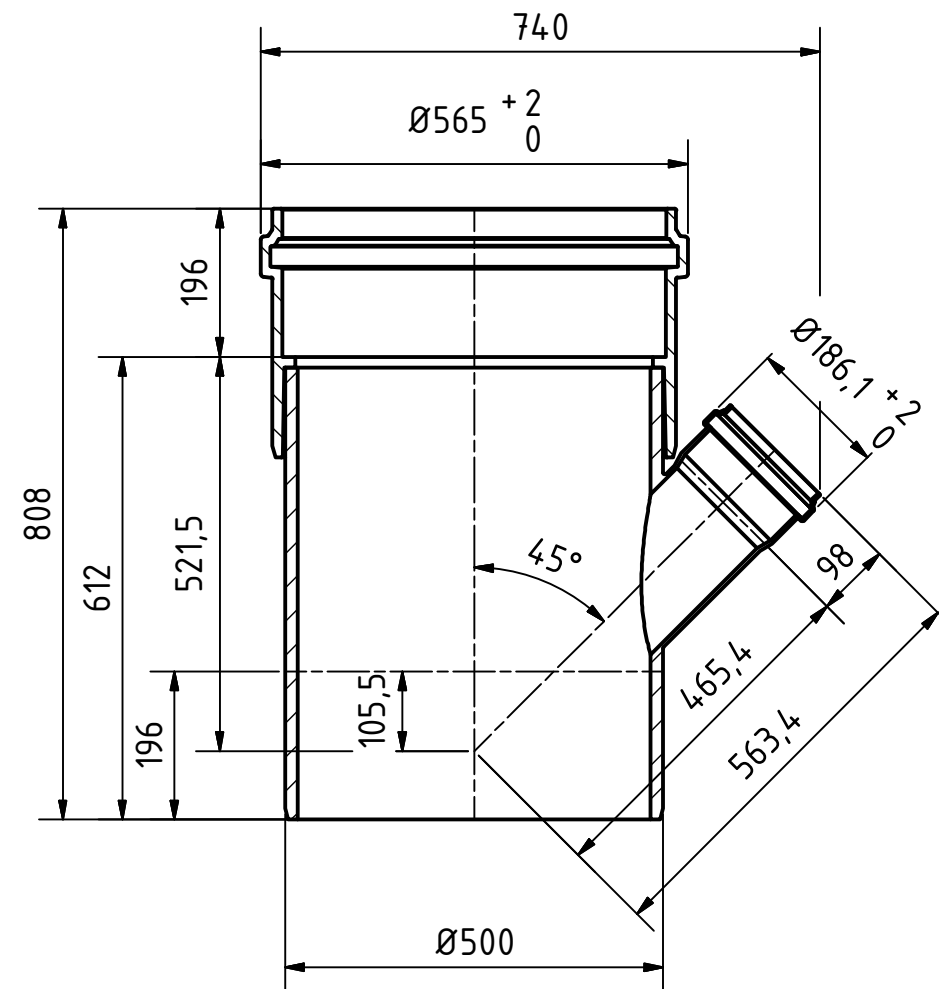

		Maße nach DIN EN 14 758-Teil1		Art.Nr.: 771130		Maßstab 1:10	
				Material: PP-MD			
		Datum		Name		<h1>KG 2000</h1>	
		Gezeichnet 04.02.2017		A.Schmedes			
		Kontroll.					
Status	Änderungen	Datum	Name	Norm			
Gebr. Ostendorf Kunststoffe GmbH Rudolf-Diesel-Str. 6-8 D-49377 Vechta verkauf@ostendorf-kunststoffe.com www.ostendorf-kunststoffe.com					KG2000EA Abzweig DN/OD 500/160/45°		1
					Schutzvermerk nach DIN ISO 16016 beachten!		