

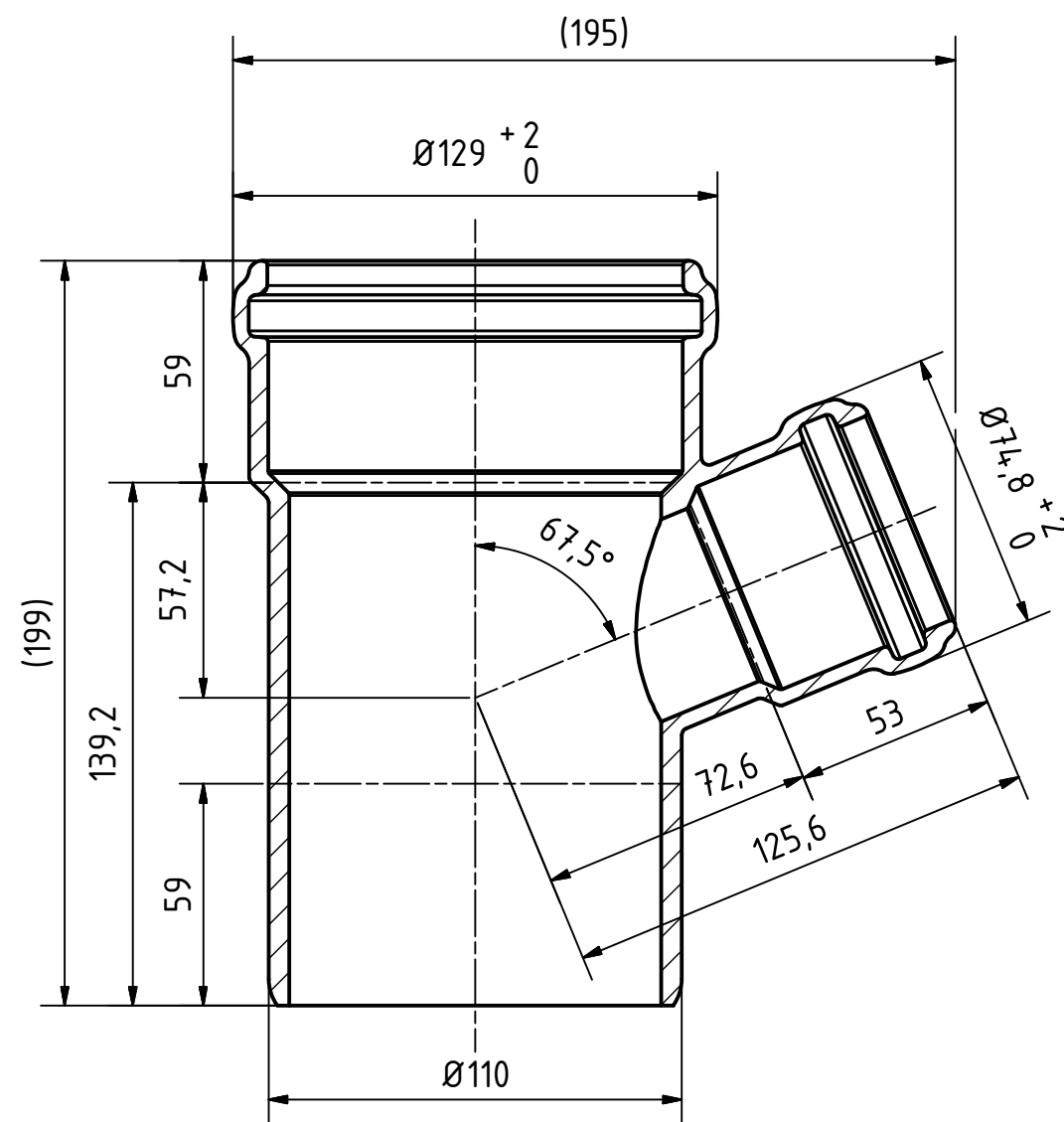

A-A (1 : 2)



		Maße nach Z-42.1-217		Art.Nr.: 335320		Maßstab 1:2		
				Material: PP-MD				
		Datum		Name		<h1>Skolan Safe</h1>		
		Gezeichnet: 08.01.2018		A.Schmedes				
		Kontrolliert:						
Status	Änderungen	Datum	Name	Norm				
Gebr. Ostendorf Kunststoffe GmbH Rudolf-Diesel-Str. 6-8 D-49377 Vechta verkauf@ostendorf-kunststoffe.com www.ostendorf-kunststoffe.com						SKOLANsafeEA Abzweig DN/OD 110/58/67°		1 A3
						Schutzvermerk nach DIN ISO 16016 beachten!		