

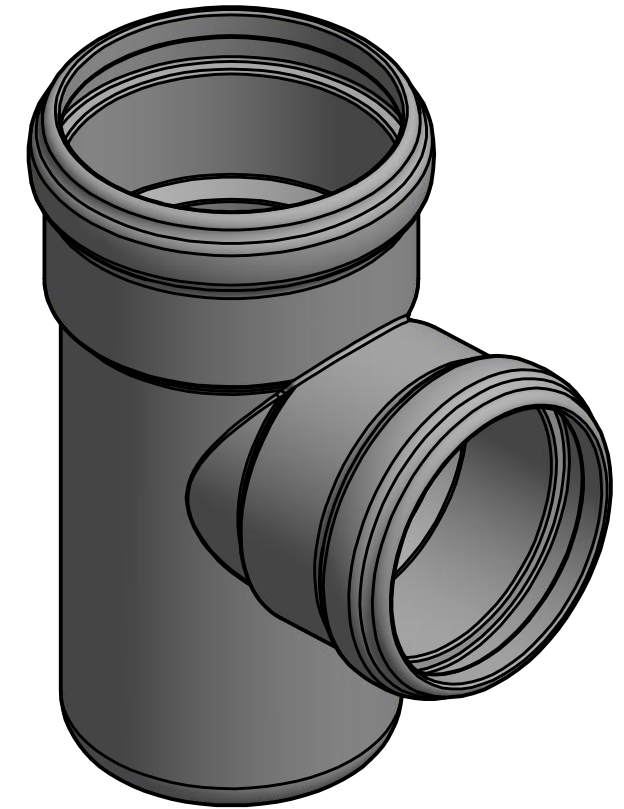

A-A (1 : 2)

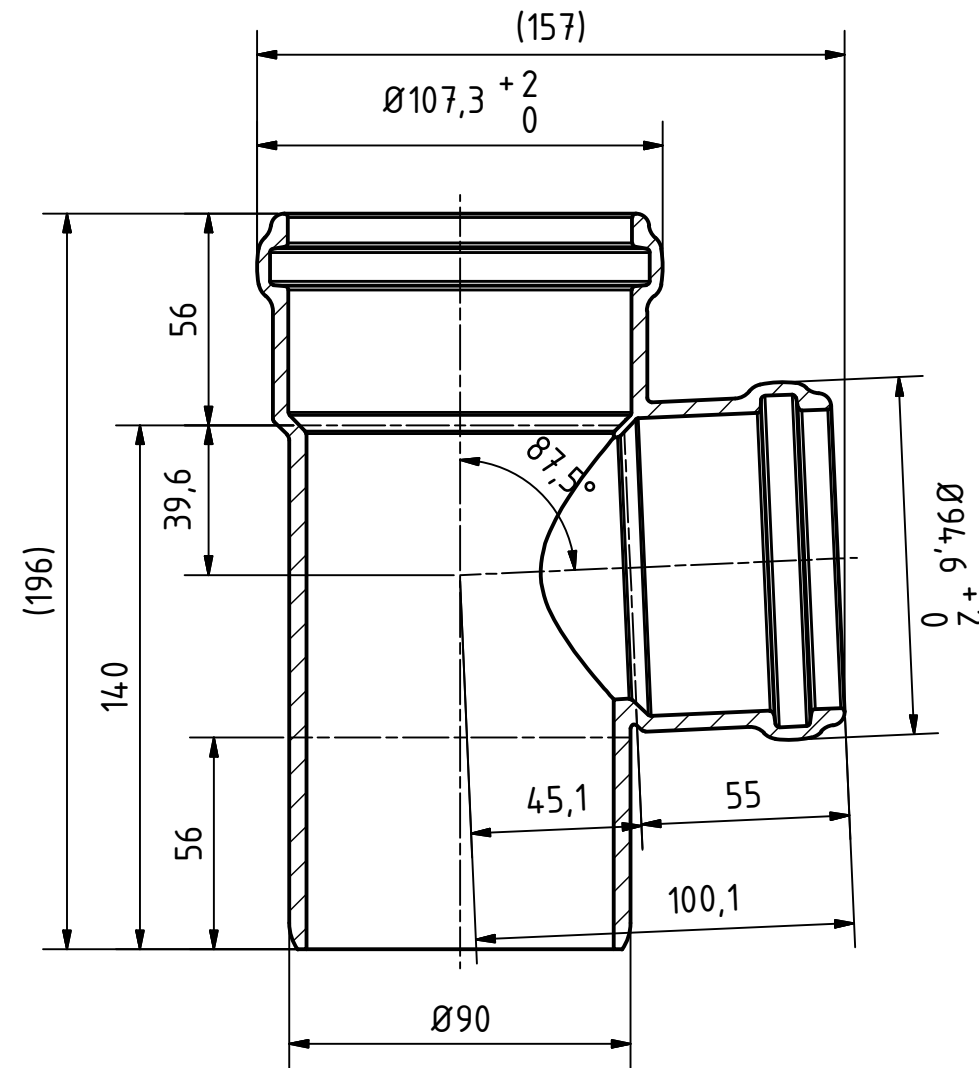

		Maße nach Z-42.1-217		Art.Nr.: 334410		Maßstab 1:2	
				Material: PP-MD			
		Datum		Name		<h1>Skolan Safe</h1>	
		Gezeichnet: 08.01.2018		A.Schmedes			
		Kontroll.					
Status	Änderungen	Datum	Name	Norm			
Gebr. Ostendorf Kunststoffe GmbH Rudolf-Diesel-Str. 6-8 D-49377 Vechta verkauf@ostendorf-kunststoffe.com www.ostendorf-kunststoffe.com						SKOLANsafeEA Abzweig DN/OD 90/78/87°	
						1 A3	
Schutzvermerk nach DIN ISO 16016 beachten!							