

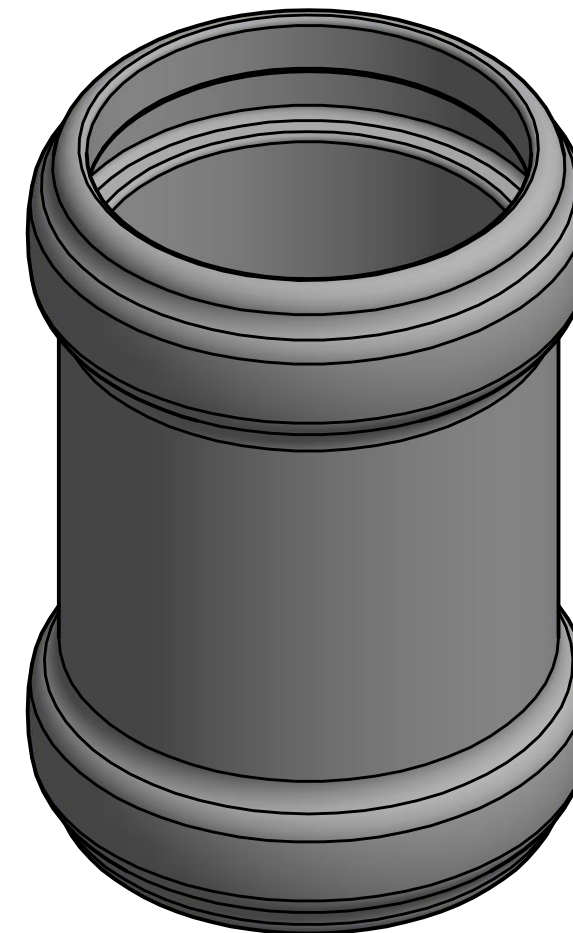

A-A (1 : 1)

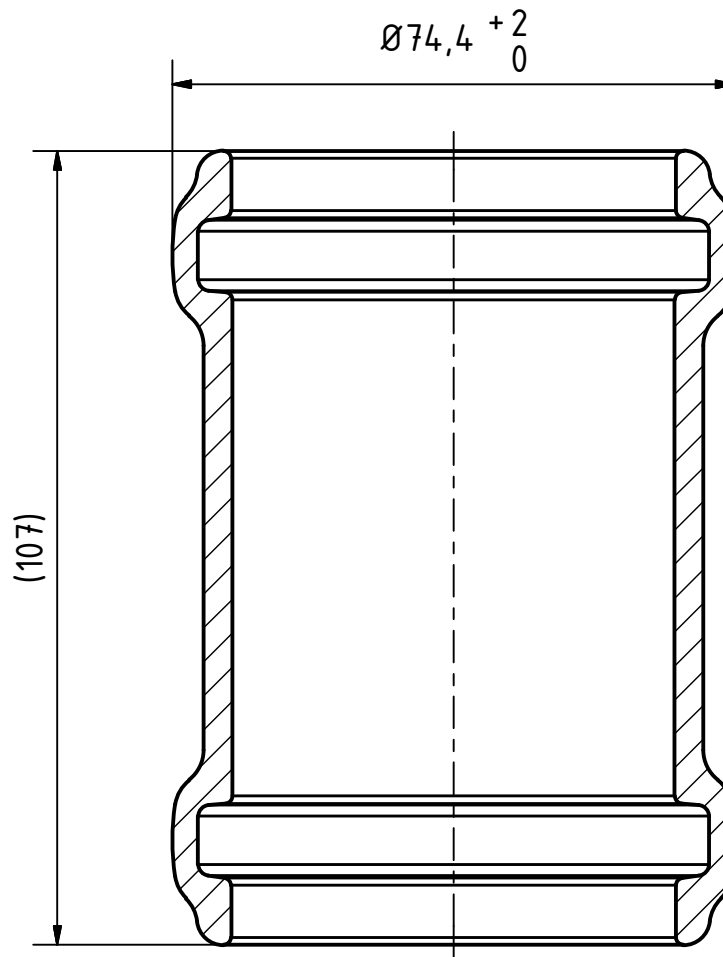

		Maße nach Z-42.1-217		Art.Nr.: 332500		Maßstab 1:1	
				Material: PP-MD			
				Datum	Name		
				Gezeichnet	21.12.2017	A.Schmedes	
				Kontroll.			
Status	Änderungen	Datum	Name	Norm			
Gebr. Ostendorf Kunststoffe GmbH Rudolf-Diesel-Str. 6-8 D-49377 Vechta verkauf@ostendorf-kunststoffe.com www.ostendorf-kunststoffe.com						<h1>Skolan Safe</h1>	
						A3	
Schutzvermerk nach DIN ISO 16016 beachten!							