

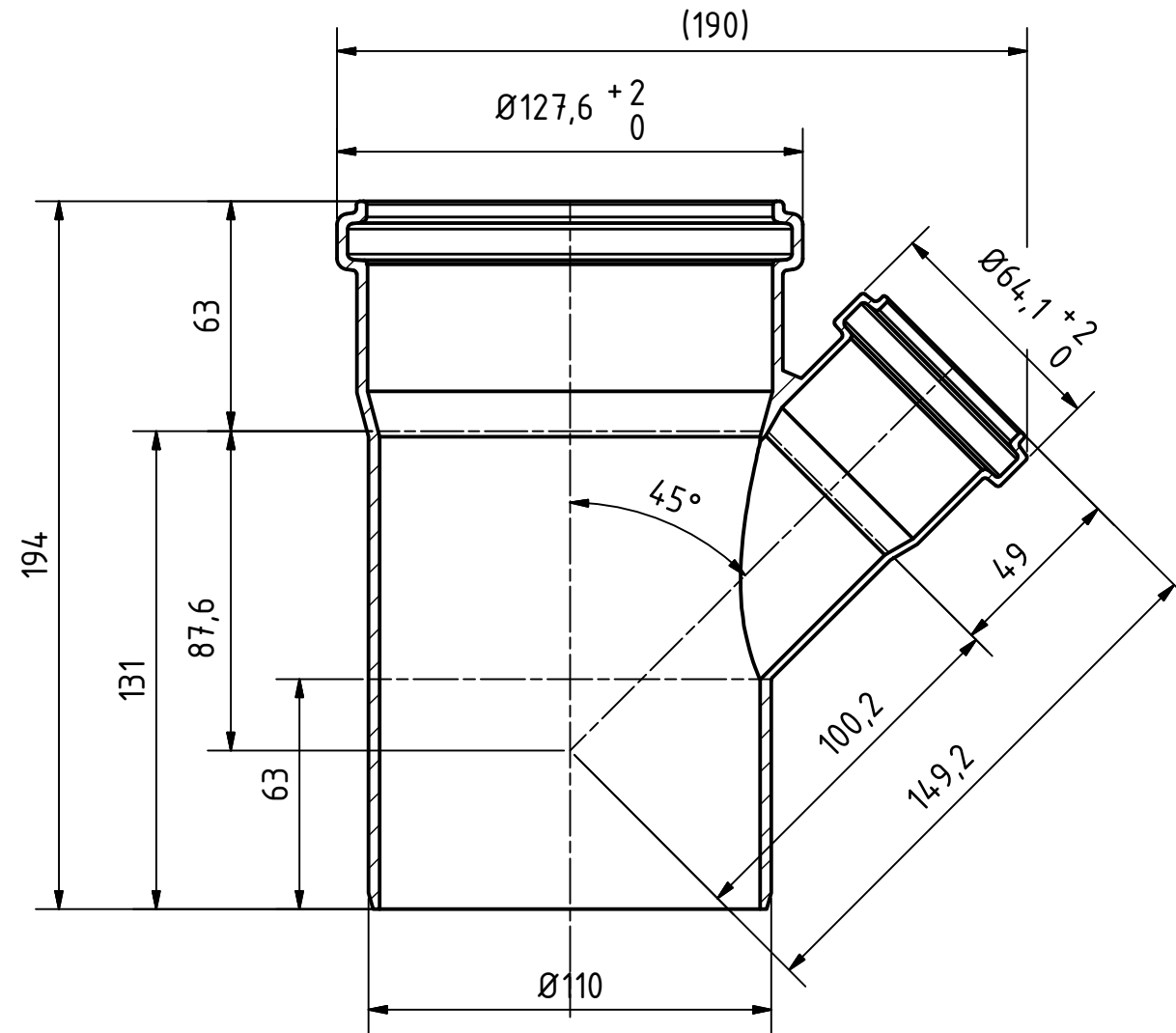

A-A (1 : 2)

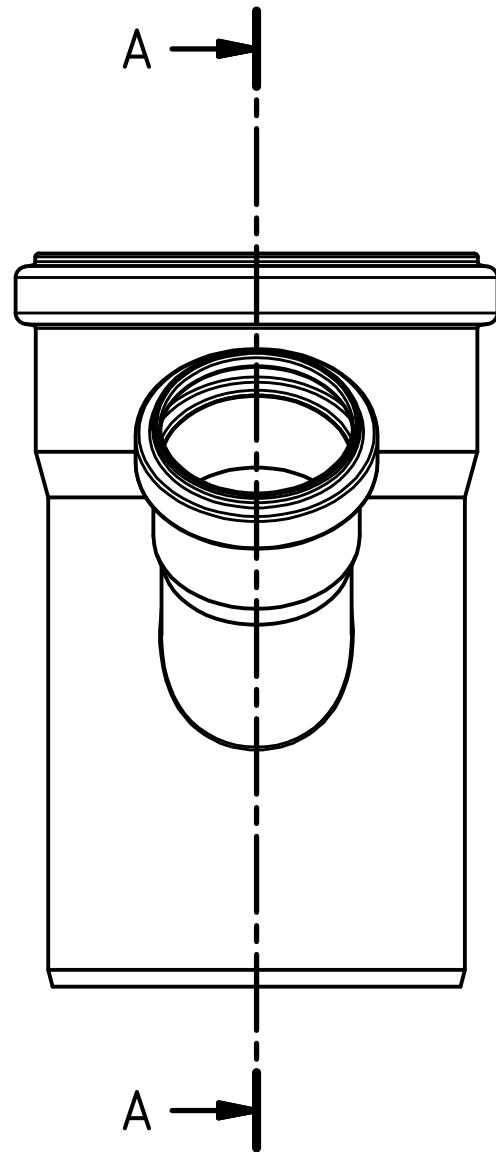

		Maße nach DIN EN 1451-1		Art.Nr.: 175220		Maßstab 1:2	
				Material: PP-H schwerentflammbar			
		Datum		Name		<h1>HT Safe</h1>	
		Gezeichnet		A.Schmedes			
		Kontroll.					
Status	Änderungen	Datum	Name	Norm			
Gebr. Ostendorf Kunststoffe GmbH Rudolf-Diesel-Str. 6-8 D-49377 Vechta verkauf@ostendorf-kunststoffe.com www.ostendorf-kunststoffe.com						HTsafeEA Abzweig DN/OD 110/50/45°	
						1 A3	
						Schutzvermerk nach DIN ISO 16016 beachten!	