

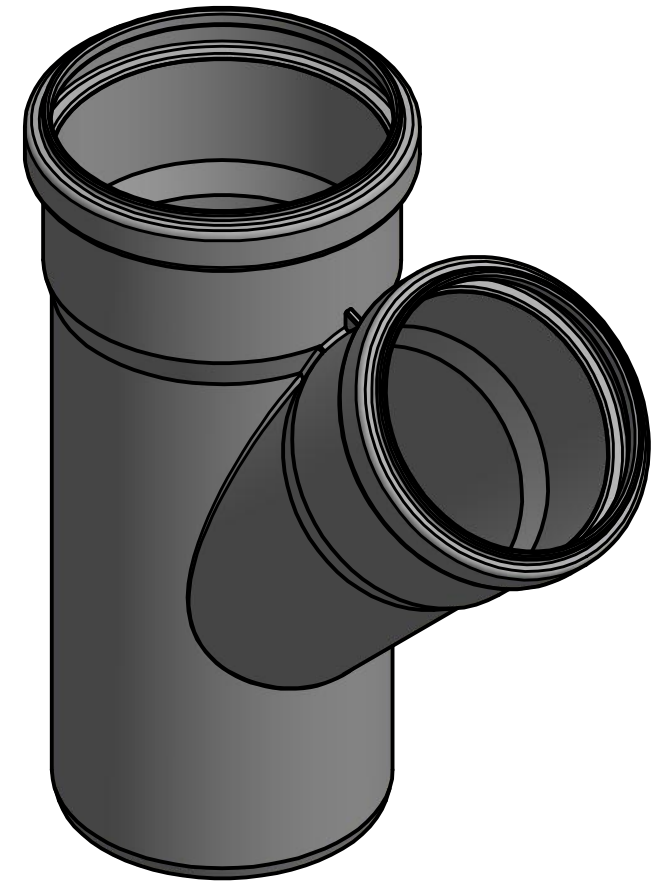

A-A (1 : 2)

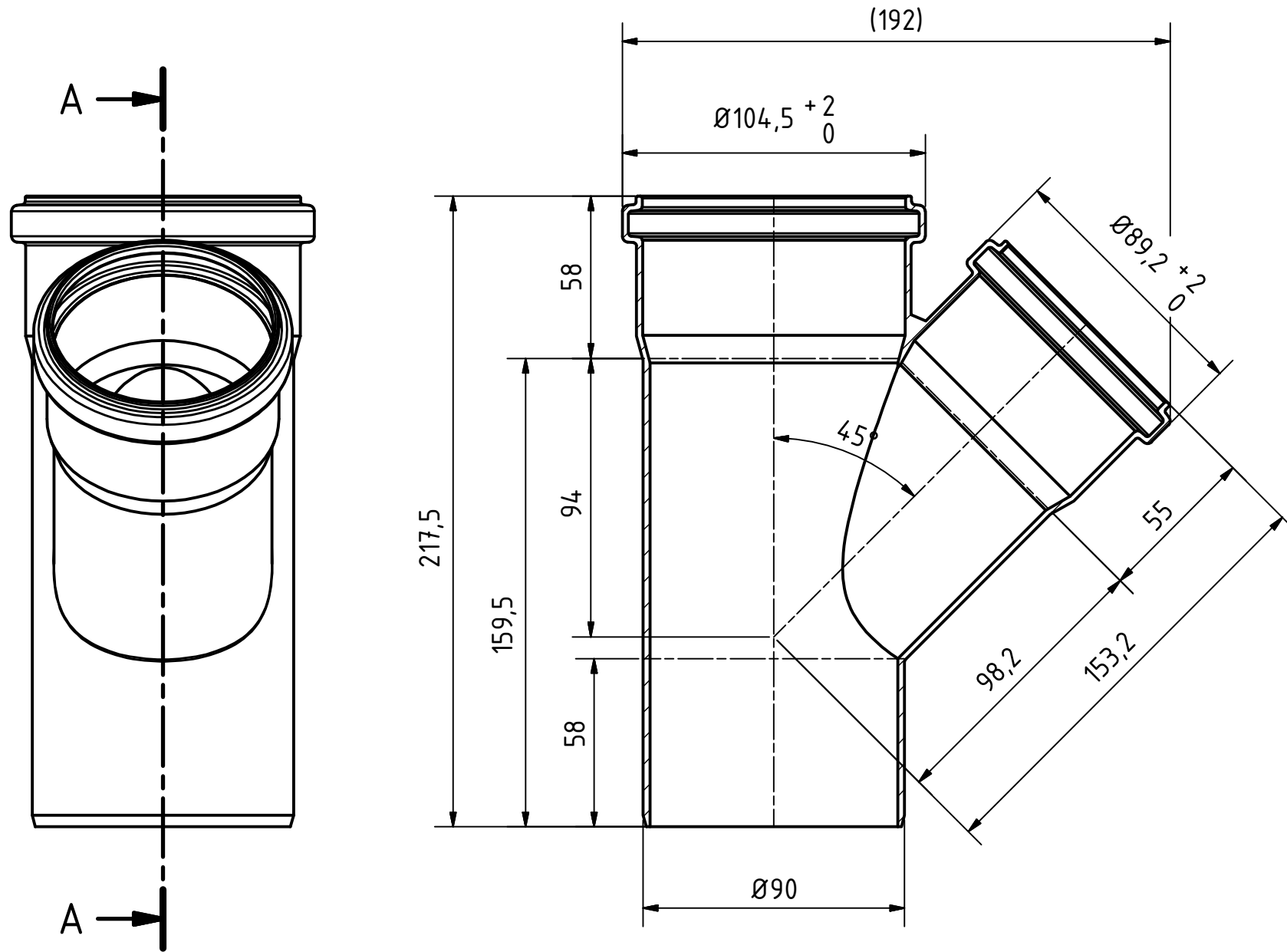

		Maße nach DIN EN 1451-1		Art.Nr.: 174210		Maßstab 1:2		
				Material: PP-H schwerentflammbar				
		Datum		Name		<h1>HT Safe</h1>		
		Gezeichnet: 30.09.2016		A.Schmedes				
		Kontroll.						
Status	Änderungen	Datum	Name	Norm				
Gebr. Ostendorf Kunststoffe GmbH Rudolf-Diesel-Str. 6-8 D-49377 Vechta verkauf@ostendorf-kunststoffe.com www.ostendorf-kunststoffe.com						HTsafeEA Abzweig DN/OD 90/75/45°		1
						Schutzvermerk nach DIN ISO 16016 beachten!		