

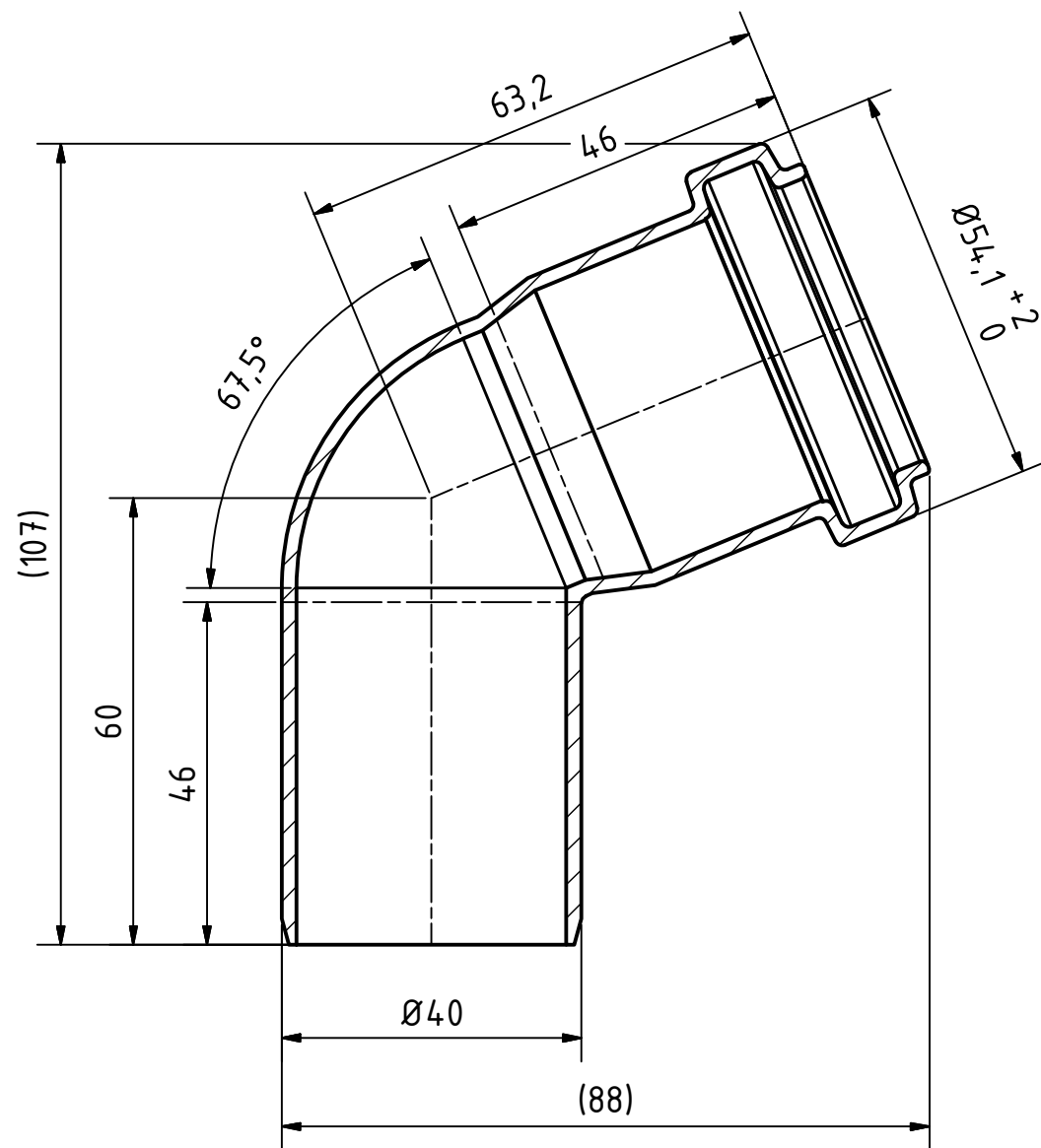

A-A ( 1 : 1 )



		Maße nach DIN EN 1451-1		Art.Nr.: 171130		Maßstab 1:1	
				Material: PP-H schwerentflammbar			
		Datum		Name		<h1>HT Safe</h1>	
		Gezeichnet: 29.09.2016		A.Schmedes			
		Kontroll.					
Status	Änderungen	Datum	Name	Norm			
Gebr. Ostendorf Kunststoffe GmbH Rudolf-Diesel-Str. 6-8 D-49377 Vechta verkauf@ostendorf-kunststoffe.com www.ostendorf-kunststoffe.com						HTsafeB Bogen DN/OD 40/67°	
						1 A3	
Schutzvermerk nach DIN ISO 16016 beachten!							